

# PROTEZIONE ANTIVIRUS

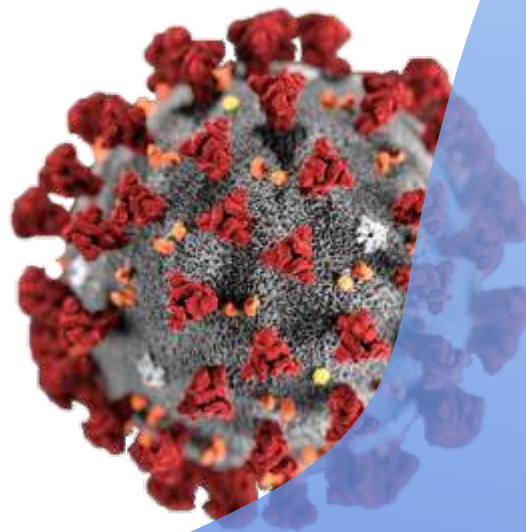

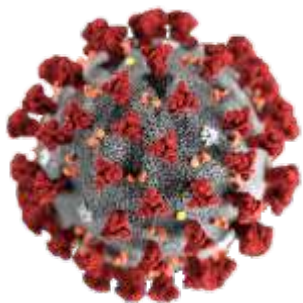

# PIANTANA PER DISPENSER GEL IGIENIZZANTE E PORTA GUANTI

Piantana autoportante in alluminio composito, corredata di:

- Cartello in forex sp. 3/5 mm con infografica personalizzabile
- Alloggiamento in plexiglass sp. 4/5 mm per igienizzante di vostra fornitura
- Alloggiamento in plexiglass sp. 4/5 mm per guanti monouso di vostra fornitura

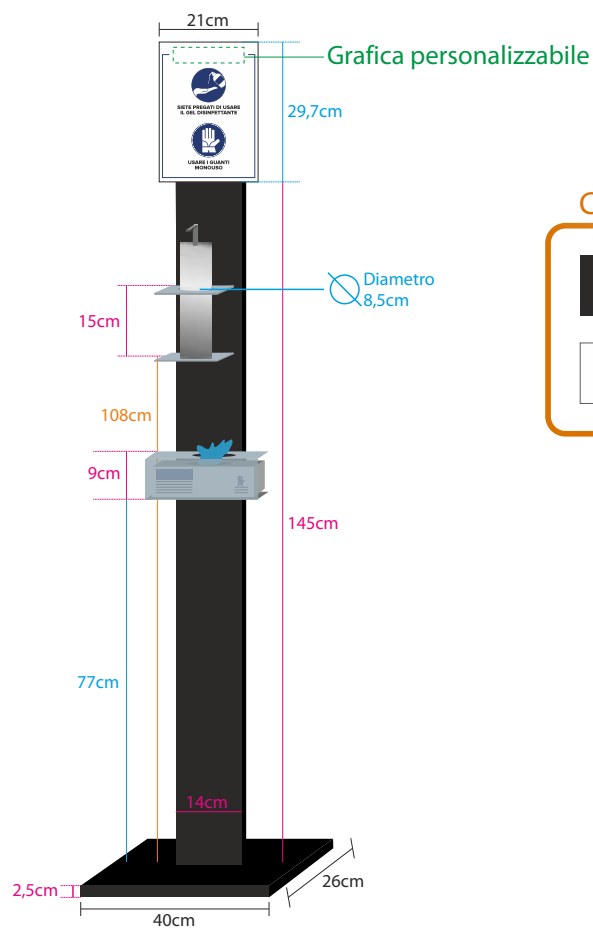

Colori disponibili:



**NERO**  
COD. 005675



**SILVER**  
COD. 005676



**BIANCO**  
COD. 005677



**GRIGIO ANTRACITE**  
COD. 005678



**DIMENSIONI**

40x145cm

**PREZZO CAD. PER QUANTITÀ**

1 - 20

21 - 40

41 - oltre

Contattaci per eventuali

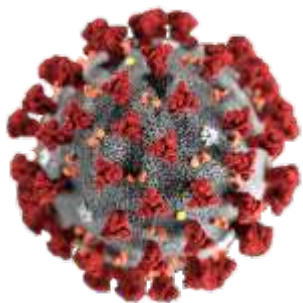

# PIANTANA PER DISPENSER ECONOMY GEL IGIENIZZANTE E PORTA GUANTI

Piantana autoportante

- Profilo in alluminio Silver
- Cartello in forex sp. 3/5 mm con infografica personalizzabile
- Alloggiamento in plexiglass sp. 4/5 mm per igienizzante di vostra fornitura
- Alloggiamento in plexiglass sp. 4/5 mm per guanti monouso di vostra fornitura

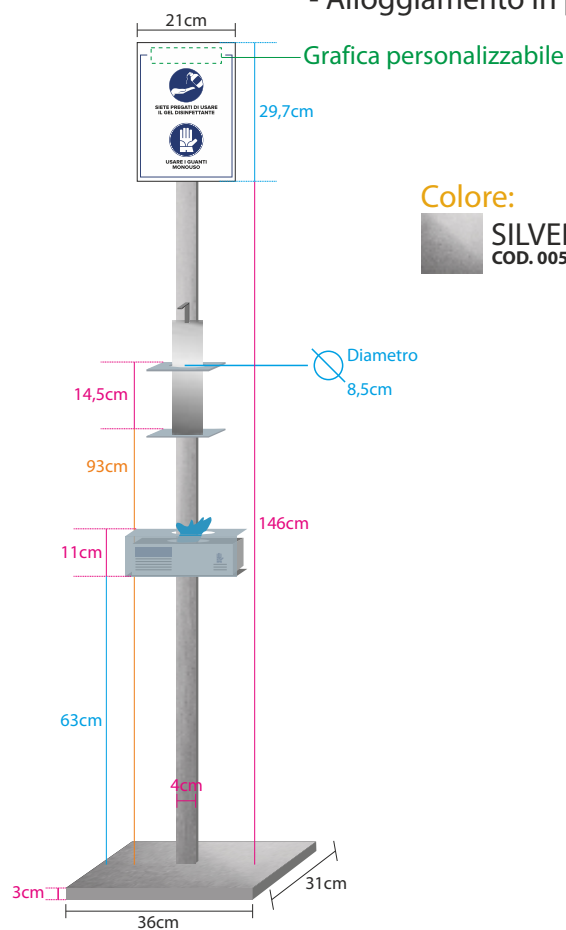

DIMENSIONI

36x146cm

PREZZO CAD. PER QUANTITÀ

1 - 20

21 - 40

41 - oltre

Contattaci per eventuali p

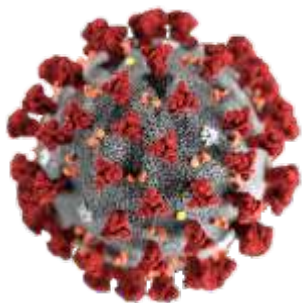

# DISPOSITIVO DI PROTEZIONE OCCHI E VISO

- Dispositivo di protezione occhi e viso:
- Schermo facciale in Policarbonato (DPI Cat. II)
  - Regolazione con fascetta a incastro

COD. 005738

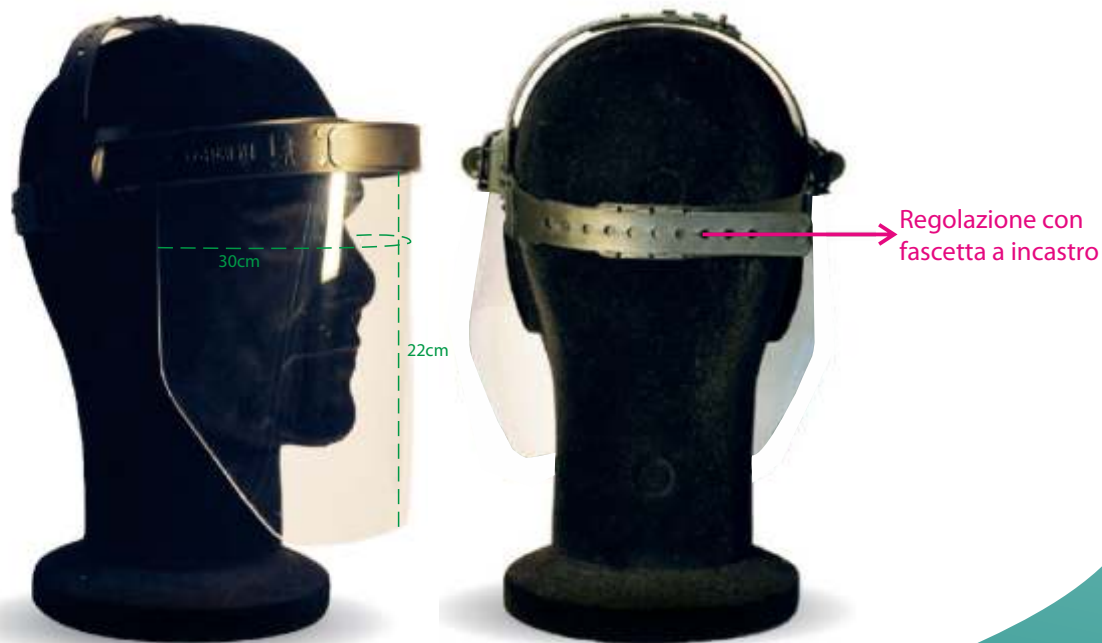

Classe ottica 1  
Livello di resistenza meccanica "5"

Riferimento Omologazione:  
Policarbonato EN 166 B  
**CE 100% MADE IN ITALY**

<b>DIMENSIONI</b>	<b>PREZZO CAD. 1</b>
visiera 30x22cm	<b>8,20€</b>

\*Prezzo IVA esclusa

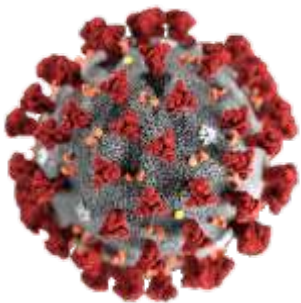

# BARRIERE MODULARI DI PROTEZIONE ANTIVIRUS PER MENSE E RISTORANTI

Barriere modulari da interni, in plexiglass, per la separazione interpersonale e il mantenimento della distanza di sicurezza.

*- Quantità e dimensioni personalizzabili*

COD. 005739





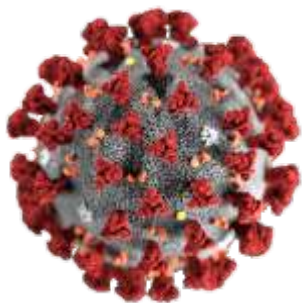

# BARRIERE MOBILI DI PROTEZIONE ANTIVIRUS

## TOTAL BODY

Plexiglass trasparente sp. 5mm - Il KIT comprende:

- 2 piedi che si incastrano nella lastra frontale
- Lastra Frontale
- 2 mensole, profondità 20cm

Opzione con o senza ruote

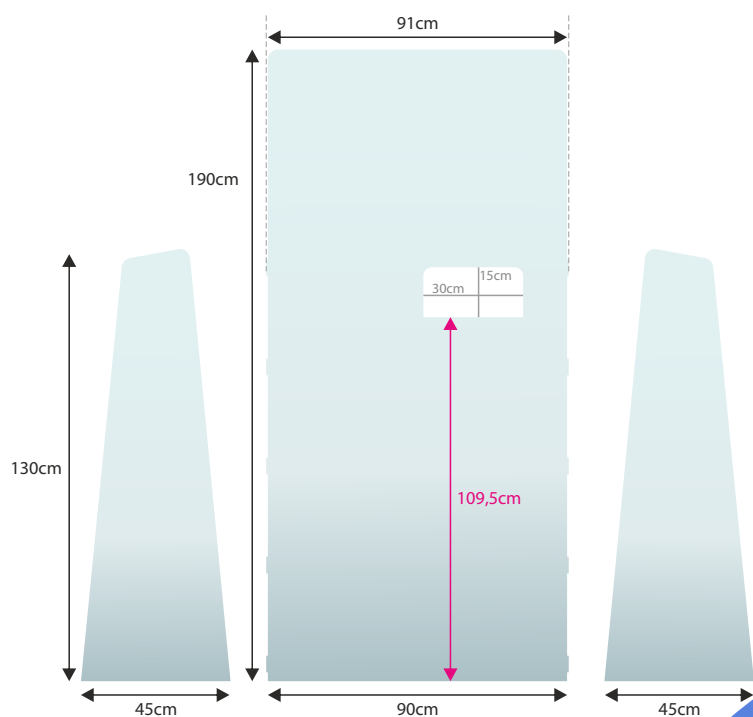

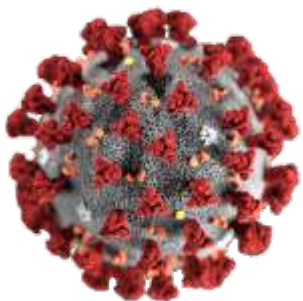

# BARRIERE MOBILI DI PROTEZIONE ANTIVIRUS DA APPOGGIO SU BANCO O SCRIVANIA

Plexiglass trasparente sp. 5/4mm - Il KIT comprende:

- 2 piedi che si incastrano nella lastra frontale
- Lastra Frontale di varie misure

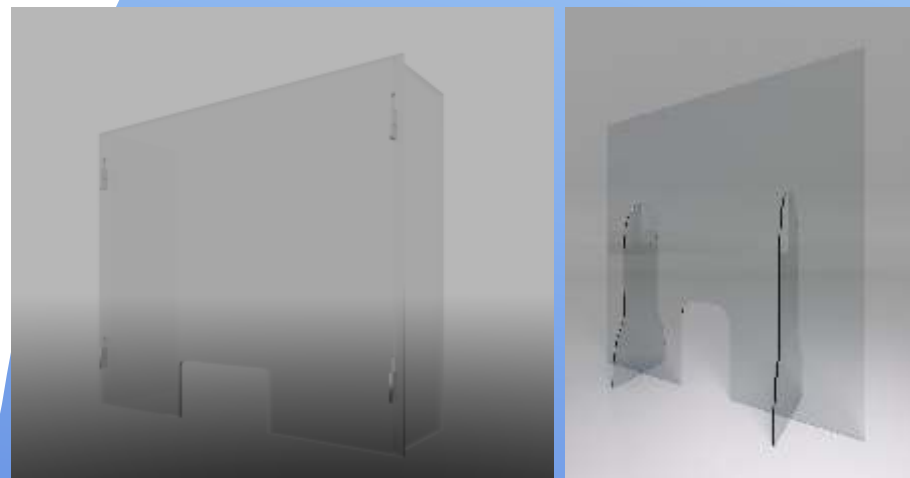
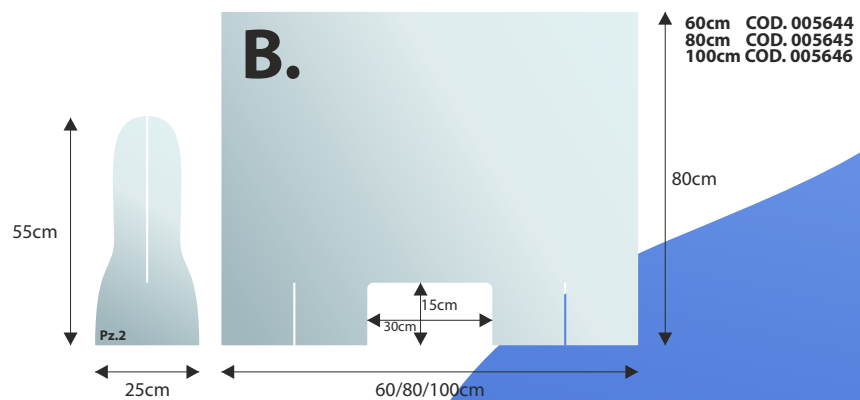
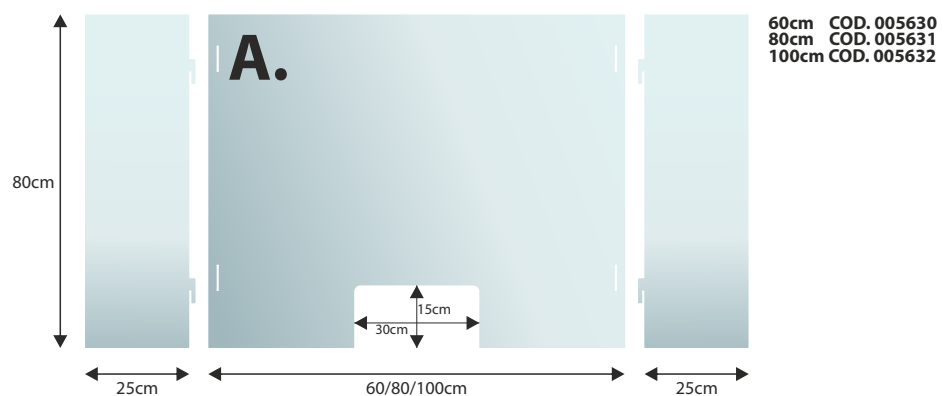

DIMENSIONI	PREZZO CAD. PER QUANTITÀ				
	1 - 4	5 - 10	11 - 25	26 - 50	51 - oltre
60x80cm					
80x80cm					
100x80cm					

Contattaci per eve

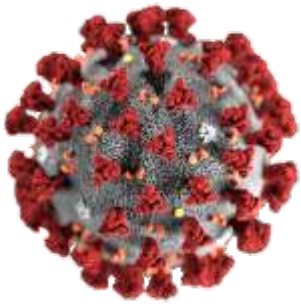

# BARRIERE DI PROTEZIONE ANTIVIRUS PER BANCHI CASSA SUPERMERCATI

Plexiglass trasparente sp. 5/4mm - Il KIT comprende:

- Lastra Frontale
  - Fissaggio mediante biadesivo di nostra fornitura
- \*Si consiglia ove possibile integrazione tramite viti

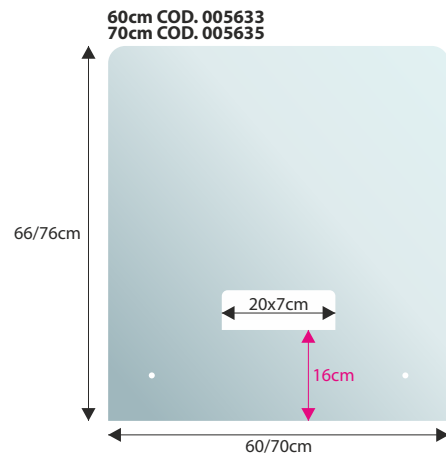

## DIMENSIONI

60x66cm  
COD. 005633

70x76cm  
COD. 005635

## PREZZO CAD. PER QUANTITÀ



Contattaci per eventi



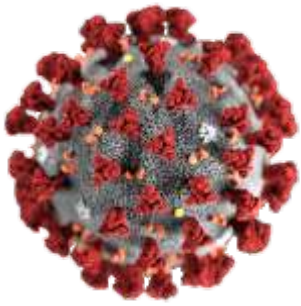

# BARRIERE DI PROTEZIONE ANTIVIRUS

## PER BANCHI CASSA SUPERMERCATI AUTOPORTANTI

Plexiglass trasparente sp. 5/4mm - Il KIT comprende:

- Lastra Frontale con piega
- Fissaggio mediante biadesivo di nostra fornitura

\*Si consiglia ove possibile integrazione tramite viti

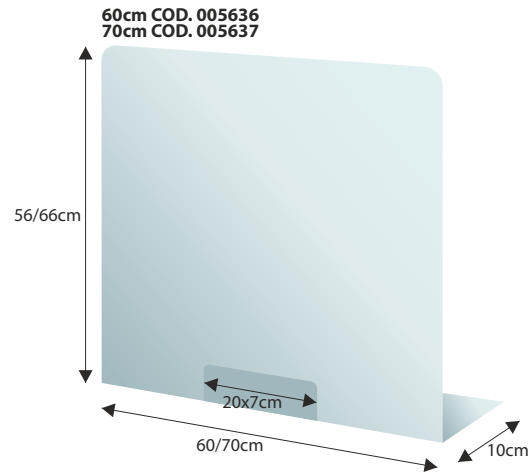

DIMENSIONI

PREZZO CAD. PER QUANTITÀ

1 - 20

21 - 50

51 - oltre

60x56cm  
COD. 005636

70x66cm  
COD. 005637

Contattaci per eventuali personalizzazioni \*Prezzo IVA esclusa



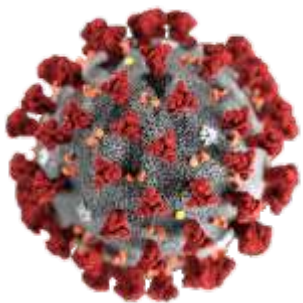

# BARRIERE MOBILI DI PROTEZIONE ANTIVIRUS PER AMBULATORI E PRELIEVI DEL SANGUE

Plexiglass trasparente sp. 5/4mm - Il KIT comprende:

- 2 piedi che si incastrano nella lastra frontale
- Lastra Frontale di varie misure

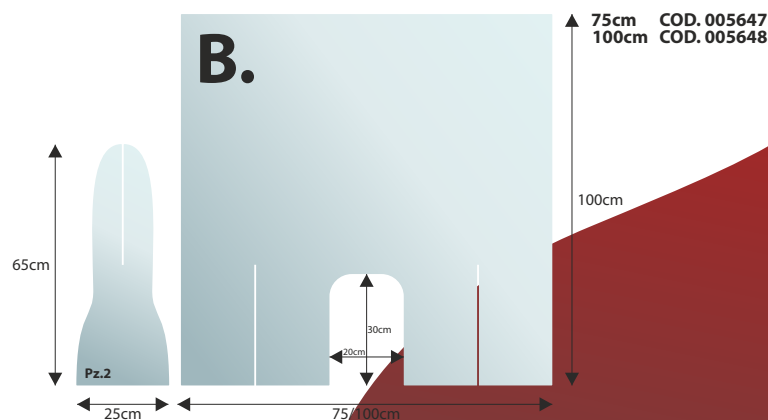
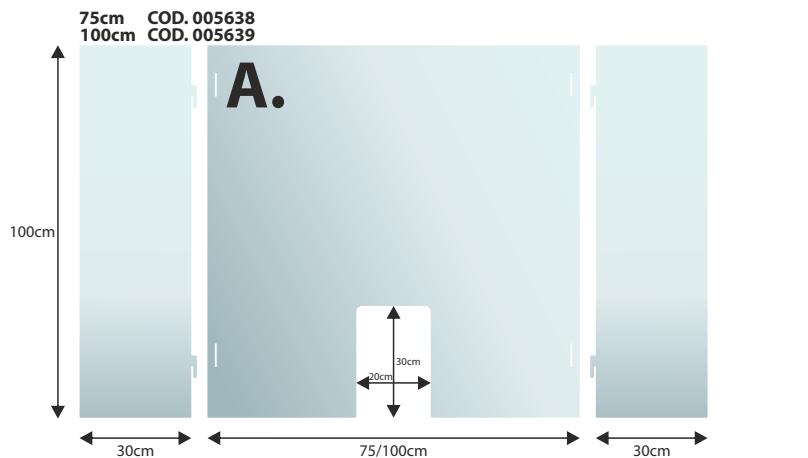

DIMENSIONI

75x100cm

100x100cm

Contattaci per event

PREZZO CAD. PER QUANTITÀ

1 - 4

5 - 10

11 - 25

26 - 50

51 - oltre

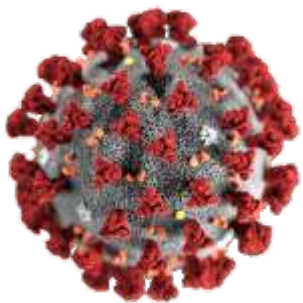

# BARRIERE DI PROTEZIONE ANTIVIRUS PERSONALIZZABILE

Contattaci per eventuali personalizzazioni

COD. 005641







**PROGETTAZIONE  
E ARREDO NEGOZI**



**TRICOMI**  
**METALLI & ARREDI**

**COMMERCIO  
METALLI**

TRICOMI METALLI & ARREDI SRL

Via Sei Aprile, 53

95131 Catania

P.IVA 04404900872

TeL +39 095 531012

TeL +39 095 532929

Mail: [tricomimetalli@gmail.com](mailto:tricomimetalli@gmail.com)

**Lun. - Ven.**

08:30 - 13:00 / 15:30 - 19:00

**Sabato**

08:30 - 12:00